

MB1240
MB1340



approximately
actual size

XL- MaxSonar[®] - EZ4[™] (MB1240) XL- MaxSonar[®] - AE4[™] (MB1340) Sonar Range Finder with High Power Output, Noise Rejection, Auto Calibration & Short-Range Narrow Detection Zone (Hardware gain of 250)

The MB1240 & MB1340 have a new high power output along with real-time auto calibration for changing conditions (temperature, voltage and acoustic or electrical noise) that ensure you receive the most reliable (in air) ranging data for every reading taken. The MB1240 & MB1340 low power 3.3V – 5V operation provides very short to long-range detection and ranging, in a tiny and compact form factor. The MB1240 & MB1340 detect objects from 0-cm* to 645-cm (25.1 feet) and provide sonar range information from 20-cm out to 645-cm with 1-cm resolution. Objects from 0-cm* to 20-cm typically range as 20-cm. (*Objects from 0-mm to 1-mm may not be detected.) The interface output formats included are pulse width output (MB1240), real-time analog voltage envelope (MB1340), analog voltage output, and serial digital output.

Features	Benefits	Applications and Uses
<ul style="list-style-type: none"> • High acoustic power output • Real-time auto calibration and noise rejection for every ranging cycle • Calibrated beam angle • Continuously variable gain • Object detection as close as 1mm from the sensor • 3.3V to 5V supply with very low average current draw • Readings can occur up to every 100mS, (10-Hz rate) • Free run operation can continually measure and output range information • Triggered operation provides the range reading as desired • All interfaces are active simultaneously • Serial, 0 to Vcc, 9600Baud, 81N • Analog, (Vcc/1024) / cm • Pulse Width (MB1240) Real-time analog envelope (MB1340) • Sensor operates at 42KHz 	<ul style="list-style-type: none"> • Acoustic and electrical noise resistance • Reliable and stable range data • Sensor dead zone virtually gone • Low cost • Quality controlled beam characteristics • Very low power ranger, excellent for multiple sensor or battery based systems • Ranging can be triggered externally or internally • Sensor reports the range reading directly, frees up user processor • Fast measurement cycle • User can choose any of the sensor outputs • No power up calibration is required • Perfect for when objects may be directly in front of the sensor during power up • Easy mounting 	<ul style="list-style-type: none"> • UAV blimps, micro planes and some helicopters • Bin level measurement • Proximity zone detection • People detection • Robot ranging sensor • Autonomous navigation • Environments with acoustic and electrical noise • Multi-sensor arrays • Distance measuring • Short range object detection • Users who prefer to process the analog voltage envelope (MB1340) • -40°C to +65°C operation (+85°C limited operation)

MB1240 & MB1340 Pin Out

Pin 1 - Leave open (or high) for serial output on the Pin 5 output. When Pin 1 is held low the Pin 5 output sends a pulse (instead of serial data), suitable for low noise chaining.

Pin 2 - MB1240 (PW) This pin outputs a pulse width representation of range. To calculate distance, use the scale factor of 58uS per cm.

MB1340 (AE) This pin outputs the analog voltage envelope of the acoustic wave form.

Pin 3 - (AN) This pin outputs analog voltage with a scaling factor of (Vcc/1024) per cm. A supply of 5V yields ~4.9mV/cm., and 3.3V yields ~3.2mV/cm. Hardware limits the maximum reported range on this output to ~700 cm at 5V and ~600 cm at 3.3V. The output is buffered and corresponds to the most recent range data.

Pin 4 - (RX) This pin is internally pulled high. The MB1240 & MB1340 will continually measure range and output if the pin is left unconnected or held high. If held low the MB1240 & MB1340 will stop ranging. Bring high 20uS or more for range reading.

Pin 5 - (TX) When Pin 1 is open or held high, the Pin 5 output delivers asynchronous serial with an RS232 format, except voltages are 0-Vcc. The output is an ASCII capital "R", followed by three ASCII character digits representing the range in centimeters up to a maximum of 765, followed by a carriage return (ASCII 13). The baud rate is 9600, 8 bits, no parity, with one stop bit. Although the voltage of 0-Vcc is outside the RS232 standard, most RS232 devices have sufficient margin to read 0-Vcc serial data. If standard voltage level RS232 is desired, invert, and connect an RS232 converter such as a MAX232.

When Pin 1 is held low, the Pin 5 output sends a single pulse, suitable for low noise chaining (no serial data).

V+ Operates on 3.3V - 5V. The average (and peak) current draw for 3.3V operation is 2.1mA (50mA peak) and 5V operation is 3.4mA (100mA peak) respectively. Peak current is used during sonar pulse transmit.

GND Return for the DC power supply. GND (& V+) must be ripple and noise free for best operation.

MB1240 & MB1340 Circuit

The sensor functions using active components consisting of an LM324 and PIC16F690, together with a variety of other components. The schematic is shown to provide the user with detailed connection information.

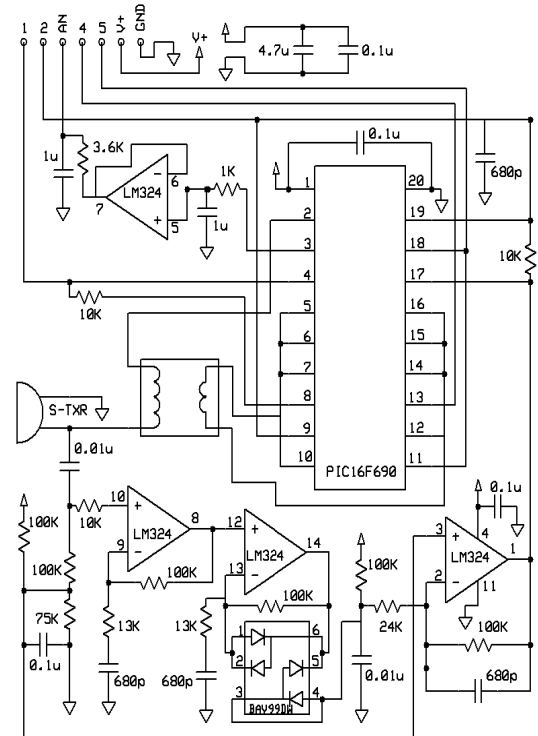

MB1240 & MB1340 Real-time Operation

175mS after power-up, the XL-MaxSonar® is ready to begin ranging. If Pin-4 is left open or held high (20uS or greater), the sensor will take a range reading. The XL-MaxSonar® checks the Pin-4 at the end of every cycle. Range data can be acquired once every 99mS. Each 99mS period starts by Pin-4 being high or open, after which the XL-MaxSonar® calibrates and calculates for 20.5mS, and after which, thirteen 42KHz waves are sent.

Then for the MB1240, the pulse width (PW) Pin-2 is set high. When an object is detected the PW pin is set low. If no target is detected the PW pin will be held high for up to 44.4mS (i.e. 58uS * 765cm) (For the most accurate range data, use the PW output of the MB1240 product.)

For the MB1340 with analog envelop output, Pin-2 will show the real-time signal return information of the analog waveform.

For both parts, the remainder of the 99mS time (less 4.7mS) is spent adjusting the analog voltage to the correct level, (and allowing the high acoustic power to dissipate). During the last 4.7mS, the serial data is sent.

MB1240 & MB1340 Real-time Auto Calibration

Each time before the XL-MaxSonar® takes a range reading it calibrates itself. The sensor then uses this data to range objects. If the temperature, humidity, or applied voltage changes during sensor operation, the sensor will continue to function normally. The sensor does not apply compensation for the speed of sound change verses temperature to any range readings.

MB1240 & MB1340 Real-time Noise Rejection

While the XL-MaxSonar® is designed to operate in the presence of noise, best operation is obtained when noise strength is low and desired signal strength is high. Hence, the user is encouraged to mount the sensor in such a way that minimizes outside acoustic noise pickup. In addition, keep the DC power to the sensor free of noise. This will let the sensor deal with noise issues outside of the users direct control (in general, the sensor will still function well even if these things are ignored). Users are encouraged to test the sensor in their application to verify usability.

For every ranging cycle, individual filtering for that specific cycle is applied. In general, noise from regularly occurring periodic noise sources such as motors, fans, vibration, etc., will not falsely be detected as an object. This holds true even if the periodic noise increases or decreases (such as might occur in engine throttling or an increase/decrease of wind movement over the sensor). Even so, it is possible for sharp non-periodic noise sources to cause false target detection. In addition, *(because of dynamic range and signal to noise physics,) as the noise level increases, at first only small targets might be missed, but if noise increases to very high levels, it is likely that even large targets will be missed.

*In high noise environments, if needed, use 5V power to keep acoustic signal power high. In addition, a high acoustic noise environment may use some of the dynamic range of the sensor. For applications with large targets, consider a part with ultra clutter rejection like the MB7092.

MB1240 & MB1340 Beam Characteristics

The MB1240 and MB1340 have a wide and long sensitive beam that offers excellent detection of objects and people. The MB1240 and MB1340 balances the detection of objects and people with minimal side-lobes. Sample results for measured beam patterns are shown to the right on a 30-cm grid. The detection pattern is shown for dowels of varying diameters that are place in front of the sensor:

- (A) 6.1-mm (0.25-inch) diameter dowel,
- (B) 2.54-cm (1-inch) diameter dowel,
- (C) 8.89-cm (3.5-inch) diameter dowel,

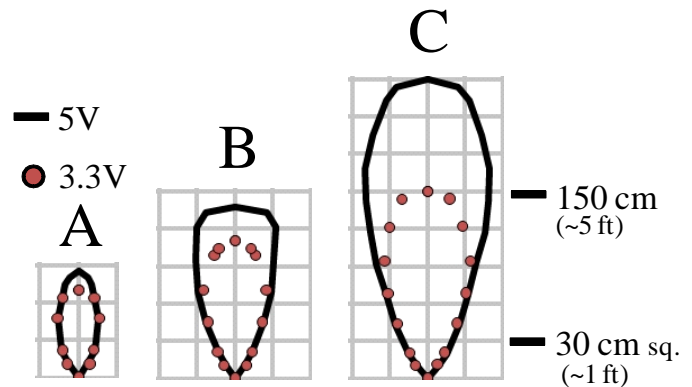

Beam characteristics are approximate

MB1240 & MB1340 Mechanical Dimensions

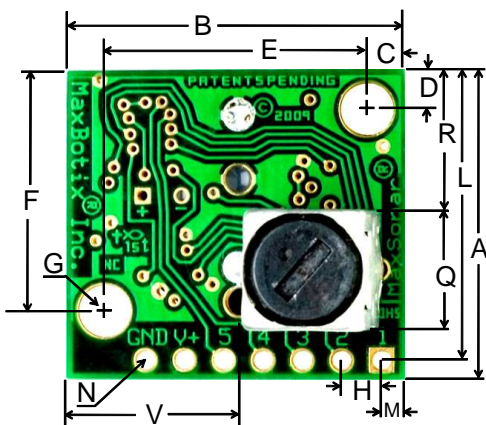

A	0.785"	19.9mm	L	0.735"	18.7mm
B	0.870"	22.1mm	M	0.065"	1.7mm
C	0.100"	2.54mm	N	0.038" dia.	1.0mm dia.
D	0.100"	2.54mm	P	0.537"	13.64mm
E	0.670"	17.0mm	Q	0.304"	7.72mm
F	0.610"	15.5mm	R	0.351"	8.92mm
G	0.124" dia.	3.1mm dia.	S	0.413"	10.5mm
H	0.100"	2.54mm	T	0.063"	1.6mm
J	0.989"	25.11mm	U	0.368"	9.36mm
K	0.645"	16.4 mm	V	0.492"	12.5mm
values are nominal			Weight, 5.9 grams		

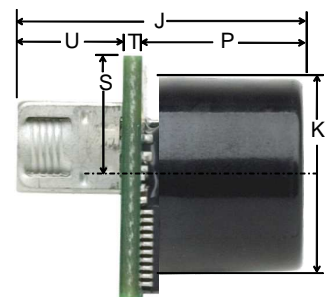

Typical Performance to Targets

Analog Envelope Output (Dowels, 5V)

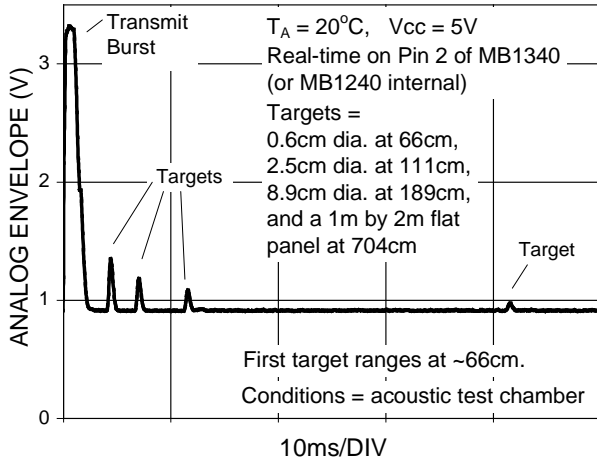

Analog Envelope Output (Dowels, 3.3V)

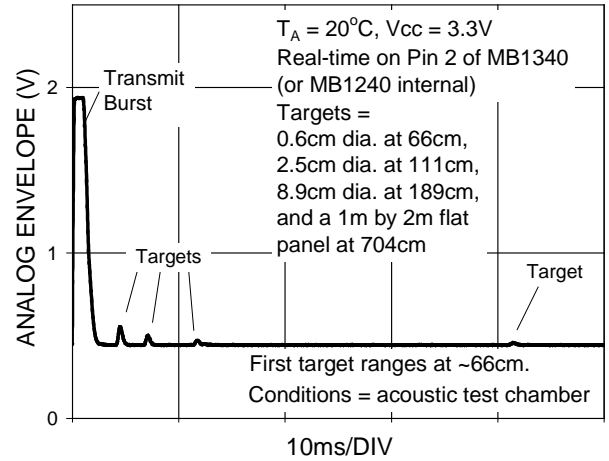

Analog Envelope Output (Dowels, 5V)

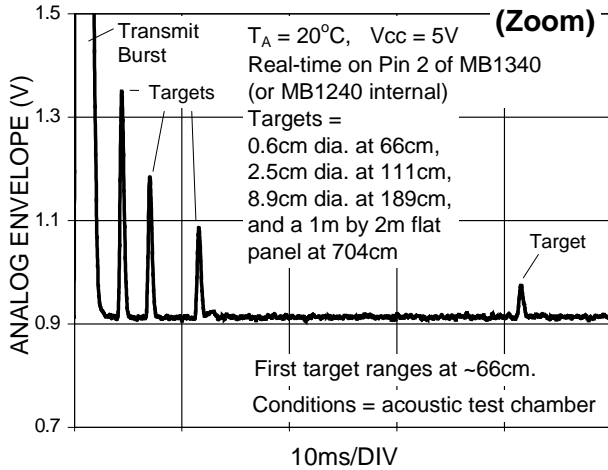

Analog Envelope Output (Dowels, 3.3V)

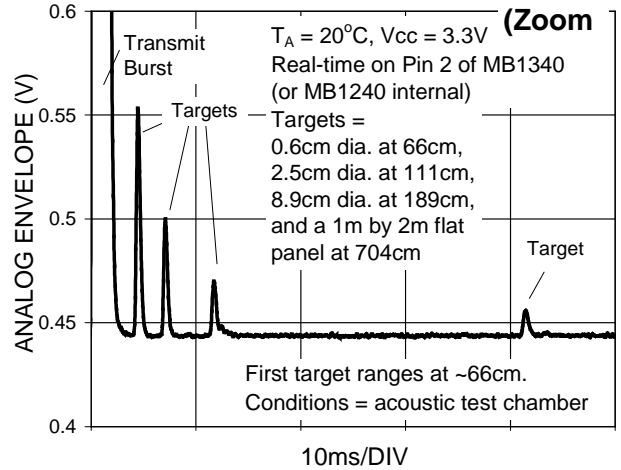

Typical Performance in Clutter

Analog Envelope Output (Clutter, 5V)

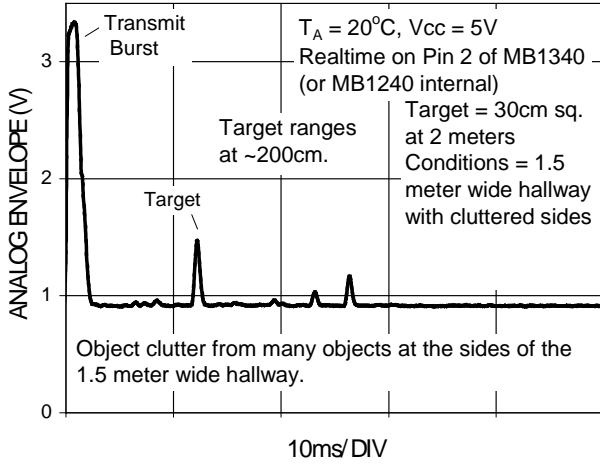

Analog Envelope Output (Clutter, 3.3V)

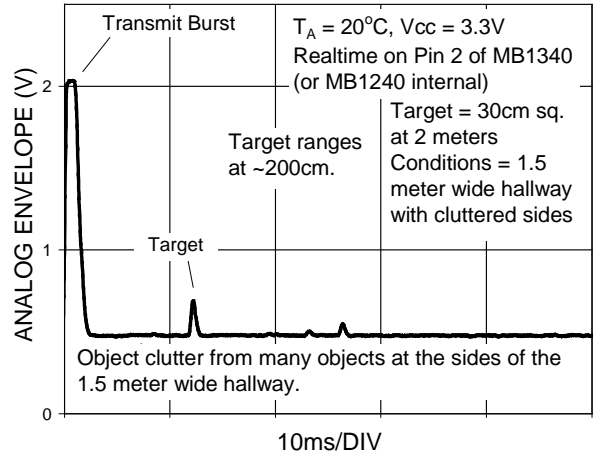

Product / specifications subject to change without notice. For more info visit www.maxbotix.com